



the LED lighting source™

COMMERCIAL • LANDSCAPE • ARCHITECTURAL • RESIDENTIAL

15 Brownridge Rd. Unit 6, Halton Hills, ON L7G 0C6 • 905-487-8192 • 1-877-LED-2DAY • SGiLighting.com

Project: _____

Client: _____

Part #: POWER-35-350MA-16D

Date: dd / mm / yyyy Qty: _____

SPECIFICATION

LED Power • 16 Watt 350mA Dimmable

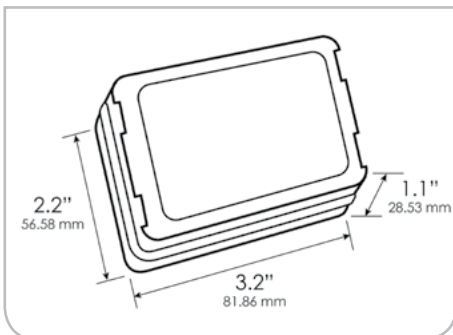

AC Input Voltage	90-135V or 176-265V * 47-63 Hz		
DC Output Voltage	24VDC Min to 48VDC Max		
Input Current Full Load	< 0.3A		
Max Load	16.8W		
Output Current Full Load	0.35A		
Efficiency	80.00%		
IP Rating	IP20		
Dimension	W	2.2"	56.58 mm
Width, Length, Height	L	3.2"	81.86 mm
	H	1.1"	28.53 mm
Weight	0.3 lbs	4.8 oz	

* Available on special order

Features

- Class 2 Dimmable LED Constant Current Driver
- Compact encapsulated assembly
- High temperature operation (up to 90 Deg C case)
- Output Over-Voltage, Over-Current and Short-Circuit Protection and Auto Recovery
- Auto Power Factor Correction
- Operates with Standard Light Switches
- Operates with Triac based Incandescent Dimmers (Standard phase - leading edge)
- Operates with Electronic Low Voltage Dimmers (Reverse Phase - trailing edge)
- UL Recognized Component
- ROHS Compliant